

# Water Heating

## 3



- 🏠 Use less hot water to save money on utility bills
- 🏠 Increase your water heater's efficiency—page 6
- 🏠 Regular maintenance makes a difference—page 8
- 🏠 Evaluate water heater features when shopping—page 9

# Reduce use and increase efficiency

## Did you know?

The Energy Policy Act of 2005 includes tax-credit provisions both for buyers of new homes and homeowners who purchase energy-saving water heaters for their principal residences during calendar years 2006 and 2007:

- Up to \$300 for installation of an approved water heater.
- Up to \$2,000 for a solar-powered system used for purposes other than heating swimming pools and hot tubs.

Although there are many ways to cut your water heating bills, they all fall into two broad categories: reducing the amount of hot water you use and making your water heating system more efficient. Fortunately, there are several strategies that can help you consume less energy and save money—and still meet your hot water needs without sacrificing comfort or practicality.

This booklet was designed to answer common questions about hot water systems and to provide you with the information necessary to make informed decisions about a wide variety of topics, ranging from repairing hot water faucet leaks and insulating water supply pipes to installing low-flow showerheads and tuning up your existing water heater. You'll also find details on what to consider when it's time to go comparison shopping for a new water heater—including an evaluation of the alternatives to the common gas or electric storage tank unit that's found in the majority of homes in Iowa and across the country.

## Get going now, but take time to plan for the future

You don't have to spend a lot to generate considerable savings on your water-heating bills. Start by making sure your existing water heater is properly maintained. Talk with everyone in your family about how they can reduce hot-water use on a daily basis. Fix the little problems, such as water leaks, that can add up to wasted dollars much faster than you'd ever imagine. And be realistic about the lifetime of your water heater; once it's seven to ten years old (or out of warranty), begin your research into new models and make plans to replace the old one. Don't wait until the water heater fails, like many people do; at that moment, you'll be reacting to a home emergency that may force you into making quick, uninformed decisions that will cost you money in the long run.

## How much of the work can you do?

If you're a competent do-it-yourselfer, you can manage many of the energy-saving projects and maintenance chores described in this book. However, if you're uncomfortable with the idea of working on plumbing or would rather hire someone to handle an upgrade or repair, don't hesitate to call a professional; the dollars saved through energy savings in future years will be worth the expense. (Of course, only a trained technician should tackle jobs that require working with natural gas, propane, electricity or electronic water heater control units.)

## Look for rebates and tax credits

Many utility companies offer **rebates** on high-efficiency gas or electric water heaters; in addition, some local electric cooperatives offer **special pricing** on energy-saving electric water heaters for customers who convert from gas models. Look for the latest offers on your utility's Web site or call the company's customer service department.

Also check the Database of State Incentives for Renewable Energy (DSIRE) at <http://www.dsireusa.org>, which features a comprehensive listing of local, state, federal and utility **incentives that promote renewable options** such as solar water heating systems.

A **tax credit** can provide significant savings, too, after you buy a qualified energy-saving water heater. However, unlike a rebate, a check for the tax credit won't arrive in your mailbox a few weeks after you make the purchase; instead, the tax credit will reduce the amount of income tax you'll pay for the year in which you put the equipment in service. Consult your tax adviser or go to the Web sites for the Tax Incentives Assistance Project at <http://www.energytaxincentives.org/> or the Alliance to Save Energy at <http://www.ase.org/>.

## Energy use in a typical home

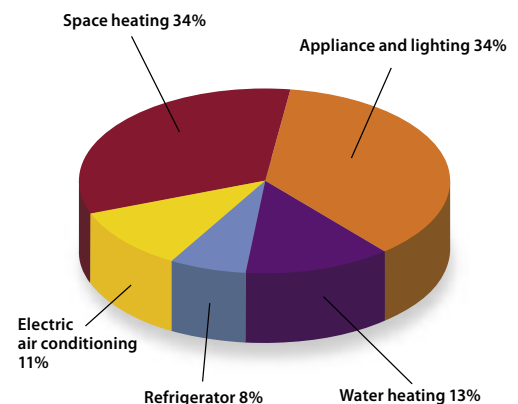

Ranking as the third-largest energy user in an average home, water heating accounts for about 13 percent of a family's utility bill.

Source: 2005 Buildings Energy Data Book, U.S. Department of Energy Office of Energy Efficiency and Renewable Energy

### Take a systems approach to lowering water-heating costs

Your water heater is more than just an appliance sitting in a corner of your basement (or a utility closet)—it’s an integral part of a whole-house hot water supply system that runs, at a minimum, to your home’s kitchen, bathrooms and laundry. Every part of this system—whether it’s a long pipe run from the water heater to a bathroom at the other end of the house or a leaky faucet at the kitchen sink—can have a dramatic effect on your monthly utility bills.

For example, you may need to run the water at a bathroom sink for a couple of minutes until it’s finally hot enough for shaving; during that time, all the cool water that’s been sitting in the pipe from the water heater just runs out of the faucet—and then down the drain. Or, if the hot water side of the kitchen faucet leaks a little bit around the handle whenever you run the water, you could be wasting a gallon or more of hot water every day—or more than 500 gallons of water a year. In an average home, that’s enough water to fill your water heater 10 or 12 times; by any measure, that’s a lot of wasted, heated water!

### Study your home to save

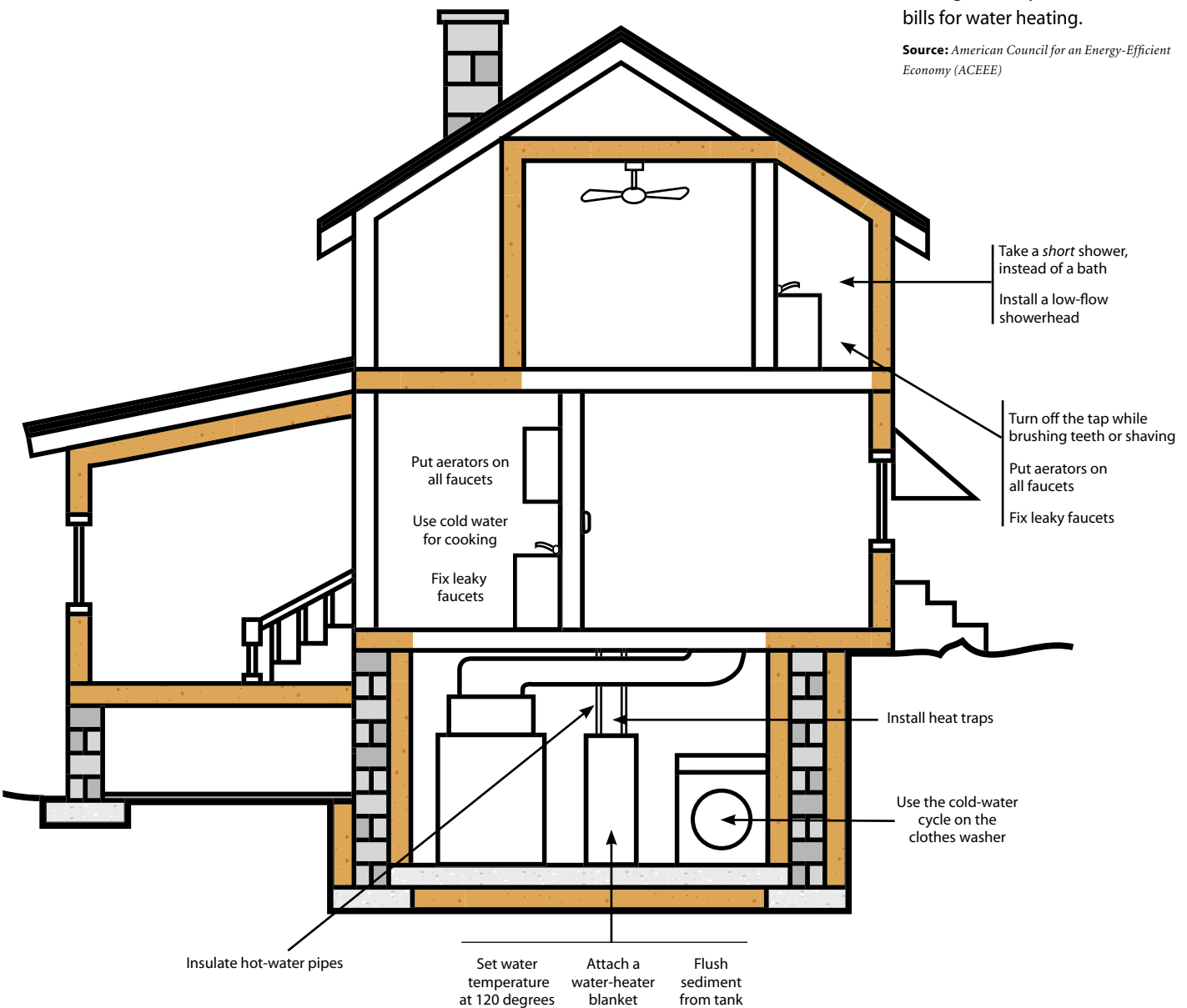

### Hot water use in a typical home

Activity	Gallons per Use
Clothes washing	32
Showering	20
Bathing	20
Automatic dishwashing	12
Preparing food	5
Hand dishwashing	4

Reducing water use from these typical levels is one of the ways an average family can shrink utility bills for water heating.

Source: American Council for an Energy-Efficient Economy (ACEEE)

## Go with the flow



Check to see if your shower is a good candidate for a low-flow showerhead with the help of a bucket and a watch with a second hand. Turn on the shower to the pressure you normally use, hold the bucket under the water flow and time how long it takes the water to reach the 1-gallon mark. If it's less than 20 seconds, your flow rate is more than 3 gallons per minute (gpm) and you should replace the showerhead.

### ? Did you know?

If you often need small amounts of hot water for cooking, you shouldn't let the kitchen faucet run for a couple of minutes. Instead, install an instant hot water dispenser at your sink. It operates just like a miniature tankless water heater—but can provide 190° F. water quickly for hot beverages, gravy or even soaking a food-encrusted pan.

## Follow these steps to use less hot water

Saving water and reducing water-heating costs go hand-in-hand. In fact, for most households it's possible to **cut the amount of energy used to heat water by 25 percent to 50 percent**— just by implementing a few water-saving steps and increasing the hot-water system's overall efficiency.

### Bathroom

<b>Close the drain before you turn on the water to fill the bathtub.</b>	Don't let the water run down the drain until it gets hot. Instead, close the drain and adjust the water temperature as the water level in the tub rises. If you can hear water leaking past the drain, replace it.
<b>Fill the bathtub to the level you really need.</b>	Small children require considerably less water than an adult; bathe babies in the sink.
<b>Take a <i>short</i> shower, instead of a bath.</b>	A bath generally uses more hot water than a shower, taking about 15 to 25 gallons of hot water; a short shower takes 10 gallons.
<b>Install a water-saving, low-flow showerhead.</b>	Older showerheads use 4 to 5 gallons per minute (gpm), while a new one uses 2.2 gpm and a water-saving unit uses 1.5 (or less) gpm. Water-saving showerheads vary in feel from a solid blast to needle-like, and some offer a "massage" feature that varies from pulsating to vigorously pounding. Look for a quality showerhead that fits your personal preferences, rather than an inexpensive unit that just restricts water flow—or you may end up with a fine, misty shower, instead of a usable water flow.
<b>Add a shutoff button to the showerhead.</b>	Some showerheads include this feature, which lets you conveniently stop the water flow while washing your hair or soaping up. If the showerhead you choose doesn't have a shutoff button, you can buy a shutoff fitting that goes between the shower pipe coming out of the wall and the showerhead.
<b>Replace a leaking bathtub diverter spout.</b>	If water continues to run from the tub spout (and down the drain) when you're taking a shower, you need a new tub spout.
<b>Turn off the tap while brushing teeth or shaving.</b>	You can lose between 5 and 10 gallons of water down the drain if you leave the water running. Instead, rinse your razor in a filled sink.
<b>Wash your hands with cool water.</b>	On average, about three-quarters of the water used in a home is hot water, so don't use heated water when you really don't need it!

### Kitchen

<b>Use cold water for cooking.</b>	Heating the water on your stove or cooktop consumes less energy than using hot water from your water heater—especially if doing so causes your water heater to cycle.
<b>For cold water from a single-handle faucet, push the handle right before starting the water flow.</b>	Pushing the handle straight up (or to the middle position) can mix hot water in with the cold. In addition, the hot water supply pipe between the faucet and the water heater will fill with hot water, cycling your water heater and wasting energy before the water even gets to the faucet.
<b>Washing dishes by hand? Rinse them in the unused half of a divided sink.</b>	Rinsing dishes under running water—especially if it's warm or hot—uses much more water and energy than just dipping the soapy dishes in a sink partially filled with clean, cold water.

## Laundry

**Use the cold-water cycle on the clothes washer for most loads, and always use cold water for rinsing.**

About 90% of the energy used for washing clothes is for heating water, so use the warm- or hot-water cycles only when absolutely necessary. Most fabrics will get clean if you use the proper cold-water laundry detergent in your washing machine.

**Adjust the water volume to fit the load size in your clothes washer.**

Run full loads or adjust the machine's water level control for smaller loads. Use less laundry detergent and fabric softener too.

## Buying new appliances

**Shop for an energy-efficient, water-saving dishwasher.**

Consider both the initial purchase price and the lifetime operating cost of the appliance. Check the yellow EnergyGuide label that tells how much electricity the dishwasher will use annually, and look for an ENERGY STAR™ label signifying that the unit uses at least 25% less energy than the minimum federal standards. Also compare features, including water temperature booster heaters, computerized "smart" controls and gallons of water used per cycle.

**Choose an energy-efficient, water-saving clothes washer.**

Evaluate both the initial purchase price and the lifetime operating cost of the appliance. Examine the yellow EnergyGuide label to find out how much electricity the clothes washer will use each year. Pick an ENERGY STAR unit, signifying that the unit uses at least 50% less energy than minimum federal standards—and uses 18-25 gallons of water per load, instead of the 40 gallons consumed by standard machines. Also look for water level controls, suds-saver settings and cycle-length controls.

## Around the house

**For just a few dollars each, install aerators on all faucets in the bathrooms, the kitchen and the laundry.**

An older faucet can deliver 2 to 4 gpm—new ones are 2 gpm or less—but a faucet aerator can reduce that amount to 1 or 0.5 gpm. In the kitchen, you may want to maintain a higher flow rate if you regularly fill large pots for cooking or use the sink for washing dishes. Some aerators include a shutoff valve that allows you to temporarily turn off the water without changing the hot/cold water mix.

**Get unusually high water pressure under control.**

If your home has unusually high water pressure, consider having a plumber install a pressure-reducing valve that can slow water flow by 20% to 50%. Reducing the pressure not only will save water, but also will help handle existing water hammer problems in your pipes.

**You may have hidden leaks in your hot-water system. Find them by performing this test.**

Locate the two water pipes coming out of the top of your water heater. One supplies cold water to the tank; the other is the hot water outlet. When you haven't used any hot water for a few hours, feel both pipes; their temperatures should be about the same. If their temperatures are notably different, repeat the test in a few more hours—making sure not to use any hot water in the meantime. If both pipes remain equal in temperature, you do not have a hot water leak. However, if only the hot water pipe is still warm, you do have a leak. The pipe will be warm all the way from the tank to the location of the leak.

## Did you know?

To save water and energy, **let your dishwasher do its job.** Pre-rinsing dishes usually is unnecessary, and the energy-saving features that came with the appliance—such as air drying—can have a significant positive impact on your utility bills.

## Get leaks under control

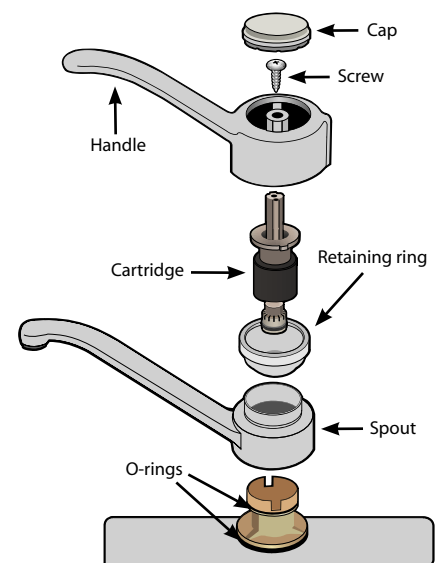

Leaky faucets waste a lot of water, energy and money. In fact, a leak that fills a cup in 10 minutes will waste more than 3,000 gallons of heated water every year.

- You can repair many faucet leaks by simply replacing some internal parts. Note the manufacturer and model number of your faucet, and take this information to a local hardware store or home center.
- If buying the parts to repair an older faucet costs almost as much as replacing it, buy a new water-saving faucet instead. Look for one with a lifetime warranty.



## Give your water heater a blanket

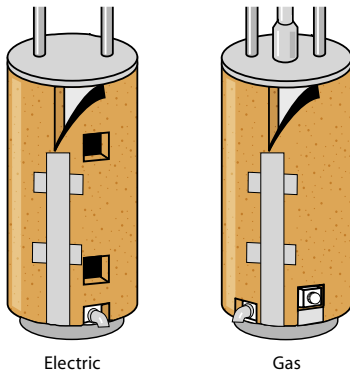

Wrapping an **insulation blanket** around the tank of your existing gas or electric water heater can save you money on water-heating bills. The insulation blanket will reduce standby heat loss—heat lost through the wall of the tank—by 25% to 45%, and you'll likely recover the cost of the blanket through reduced water-heating bills within a year.

- Check the owner's information that came with your water heater to make sure the manufacturer doesn't prohibit installing an insulation blanket.
- Look for a blanket with an insulation value of R-11 or higher.
- Buy a blanket kit designed for your type of water heater, and carefully follow the installation instructions. For example, on electric water heaters you should avoid covering the unit's thermostats. For gas water heaters, steer clear of the thermostat, air inlet at the bottom and the flue on top of the unit.

### CAUTION!

The latest energy-efficient water heaters have very high insulation levels, which eliminates the need for adding an insulation blanket. In fact, the manufacturers of many super-insulated models recommend not adding any additional insulation to the tank and may void the appliance's warranty if you do so.

## Increase your water heater's efficiency

In addition to cutting the demand for hot water, there are many things you can do to improve the efficiency of your existing water heating system. Some of these upgrades cost just a few dollars and will take you only a few minutes to complete—while others require a larger investment and installation by a professional technician—but all will pay for themselves through reduced utility bills during the normal lifespan of a water heater.

### Insulate the hot water pipes

A great deal of energy and water is wasted—literally going down the drain—while you wait for hot water to reach the sink or shower. **Insulating your hot water pipes will help reduce heat losses** as the hot water flows to your faucet or showerhead, and it will help minimize standby losses when the tap is turned on more than once an hour. Even with insulated pipes, the water eventually will cool—but the water will stay warmer longer than it would if the pipes were not insulated.

Your hot water system is a good candidate for pipe insulation if:

- ▶ You use water frequently throughout the day; e.g., everyone in your home takes a shower in the morning, one right after the other.
- ▶ The water pipe runs in your home are long.
- ▶ The pipes pass through an uninsulated crawl space or basement.

These types of water pipe insulation are available:

- ▶ *Fiberglass batts.* These thin batts come on a roll, and wrap the pipe, securing the batt in place with tape as you go.
- ▶ *Foam or fiberglass tape.* Both types come on a roll, and they're self-adhesive so they'll stick in place as you wrap the pipes.
- ▶ *Foam or synthetic rubber tubes.* Commonly sold in six-foot lengths, these tubes are split lengthwise so all you do is slip them over the pipes and secure them. Some types are held in place with zip ties or tape, while others include self-adhesive strips along their cut lines. Rigid foam tubes usually have a higher insulation factor than the less-expensive flexible foam tubes, but the flexible ones are easier to trim and cut for corners or T-joints in pipe runs.

Before you go shopping, measure the length and diameter of the water pipes you want to insulate. You may need a couple of sizes if you're planning to insulate both the main hot water supply line (often 3/4-inch pipe) and the branch lines (1/2 inch) to individual fixtures and appliances. At the store, you'll need to balance cost, convenience of installation and insulation factor; for example, even though fiberglass insulation may have a higher R-value than foam tubes, it costs more and will take longer to install—and its payback period will be longer.

Vacuum the dust and debris off the pipes before you begin installation; wear safety glasses to keep any remaining debris that gets knocked loose from falling in your eyes; for fiberglass insulations, wear gloves and a dust mask too. Insulate the first six feet of both the hot and cold water pipes, starting where the pipes go into the water heater. Also insulate the hot water pipe runs that go to frequently used fixtures or appliances.

### Add a timer or load controller to an electric water heater

A **timer** may save you money but before investing in one, contact your utility company to see if it offers a **water heater load-control program**. If it does, the utility will have an automatic means of turning off your water heater during specified time periods, so you won't need to install a timer. If your utility doesn't have an automatic way to shut off your water heater but still offers off-peak rates, then a timer could provide savings.

A timer that shuts down your water heater during the day when no one's home or at night when everyone's asleep will cost around \$50 plus professional installation, so it may take over a year to pay for itself. Timers for gas water heaters with pilot lights are not nearly as useful or as cost-effective because the flame is always burning, limiting the savings.

## “Thermosiphoning” is a word you need to know

Metal is an excellent conductor of heat, and both hot and cold water pipes offer a thermal shortcut for escaping heat. You can observe this phenomenon by placing your hand on the hot and cold water pipes leading from your water heater at varying distances from the tank. Both pipes probably will be warm, which is a sure sign of unwanted heat loss.

Heat is carried out of the tank by the movement of hot water mixing with cold water in the pipes—called **thermosiphoning**—even when no water is being drawn out of the taps. Hot water is buoyant, so it tends to rise in any vertical pipe, such as the main hot water line. That hot water then releases its heat to the pipe (and the air surrounding the pipe) until the water cools and sinks back down into the tank.

The best way to prevent this type of heat loss—called a **convection loop**—is to install **anti-convection valves** on the pipes leading into and out of the tank. The simple, one-way valves go where the pipes attach to the tank and prevent cooled water from settling back into the tank and being replaced by hot water. The best time to have a plumber install anti-convection valves is when the water heater is being replaced; the savings in water-heating costs may not be enough to justify the expense of installation on an older water heater.

A less-expensive alternative—especially if you know how to work with copper pipe—is to install **heat traps** in the cold-water pipe leading to the tank and the hot water pipe going away from it. These traps are made from copper pipe and are almost as effective as anti-convection valves; however, heat traps probably are not a cost-effective choice if you have to pay for professional fabrication and installation for an existing water heater.

## Stop dumping dollars down the drain

Most of the energy used to heat water goes down the drain, so recapturing that warmth and reusing it makes sense. According to the U.S. Department of Energy, installing a **drain waste-water heat recovery system** can produce energy savings of 25 to 30 percent for water heating.

This system uses a heat exchanger to absorb the heat from water flowing through the drainpipes of sinks, showers, bathtubs and appliances. The reclaimed heat then preheats the cold water flowing into the water heater, so the water heater doesn't have to cycle as long to heat the water to the set temperature. This has two benefits that result in energy (and cost) savings: recycling the warmth from water already heated and cutting the recovery time for a storage tank water heater (or the cycling time of a demand/tankless or solar water heating system).

A whole-house drain waste-water heat recovery system is a good choice if you're building a new home or extensively remodeling one, because it will be difficult to install in an existing home. A heat exchanger assembly replaces the drainpipe at each often-used fixture or appliance. Some models are *passive* and work best with showers and other continuous-flow fixtures, while others are *active* and include a small electric pump to circulate the water from the heat exchanger at dishwashers and other batch-flow sources.

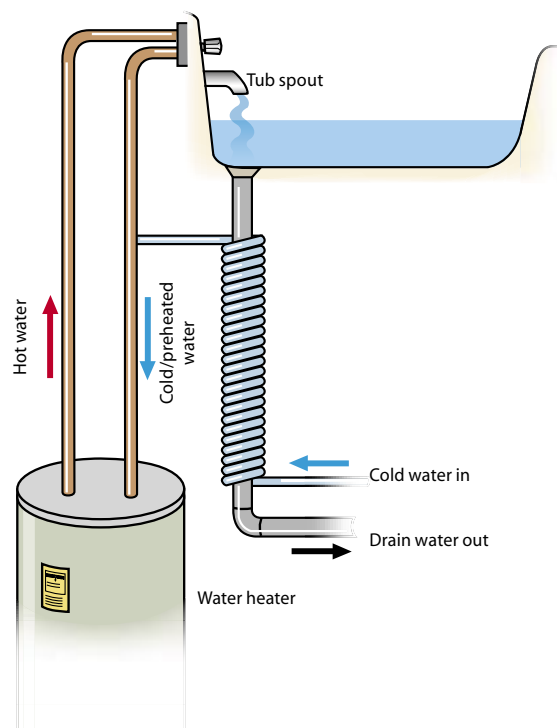

## Keep hot water where it belongs

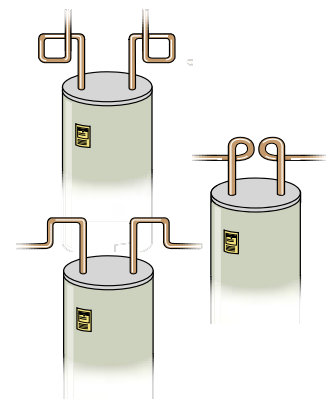

Heat traps fabricated from copper plumbing pipe can help prevent heat loss from a storage-type water heater.

## Get hot water faster

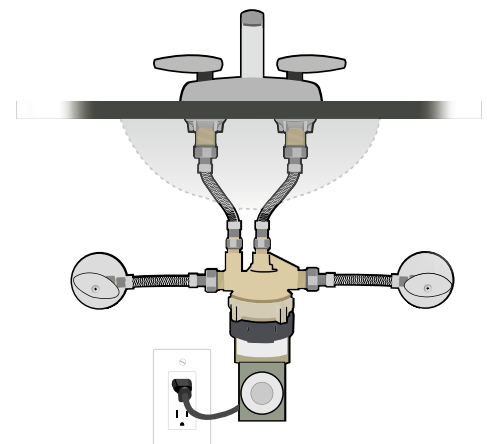

An automatic quick-delivery water-circulating unit can bring hot water to your faucet in seconds. When you open the hot water faucet, a small high-volume pump starts and within 15 seconds delivers hot water from the water heater through the regular hot water pipe. However, instead of just dumping the cold water in the pipe down the drain, a diverter valve in the device redirects it to the cold-water pipe. As soon as the hot water reaches the faucet, the valve closes and the pump shuts off. Some kits also include a timer, so you'll have hot water as soon as you get up in the morning and turn on the faucet.

**CAUTION!**

If the drainpipe connected to the **pressure relief valve** near the top of your gas or electric water heater tank is warm over most of its length (or there's a puddle on the floor underneath the pipe), the valve probably is leaking. You can check the valve yourself, but if you don't feel comfortable working around hot water that's under high pressure, get in touch with a plumber. Before replacing the valve, first try to flush it out by slightly moving the control lever attached to the valve and releasing a small amount of water. This sometimes will flush out the sediment stuck in the valve; if it doesn't, you probably will need a new one. *Note:* If the valve shows no signs of leaking, don't open it; otherwise, you may damage it and cause it to leak!

**Did you know?**

A gas water heater can tell you when **it's time to call a plumber or service technician**. For example, the burner should have a clean, blue flame; if it's mostly yellow, the burner may need to be cleaned or fine-tuned. If the pilot flame is mostly yellow, flickers or is more than about an inch long, it requires an adjustment. And if the pilot won't stay lit, the thermocouple probably has failed and needs to be replaced.

## Regular maintenance makes a difference

There are a couple of things you can do to make sure you're getting the most out of your water heater now—and to help it last a little longer too. **Be sure to check the manufacturer's information booklet for special instructions before you start.**

### Turn the knob, and save 10 percent on water heating costs

For most households, **a temperature of 120 degrees will meet your hot water needs**. This is well below the 140-150 degrees found in many homes. Excessively high water temperatures can cause these problems:

- ▶ The higher the water heater temperature, the faster the system will lose heat—and the longer the system will take to cycle.
- ▶ Higher temperatures increase the rate of corrosion on internal fittings and other surfaces, shortening the life of the water heater and other parts of the water heating system, including pipes, valves and faucets.
- ▶ Hot tap water is a scalding hazard, especially to children and seniors. Scalding occurs in two seconds at 150 degrees, while it takes 10 minutes for scalding by 120-degree water.

**Each 10-degree drop in temperature will save three to five percent on water heating costs.**

Most people find the 120-degree temperature to be satisfactory, especially considering that a "hot" shower usually runs around 105 degrees. However, if you have an older dishwasher that does not have a water-heating booster, a 140-degree temperature may be necessary for the appliance to effectively clean dishes, kitchen utensils and pots and pans.

Determine the hot water temperature by running hot water into a bowl for at least a minute and checking the temperature with a candy thermometer. If the temperature is higher or lower than 120 degrees, adjust the thermostat on the water heater a little bit, wait an hour and recheck the temperature.

For a gas water heater, turn the thermostat knob on the outside of the tank. Electric water heaters often have two thermostats—one for the upper heating element and one for the lower heating element. Before removing the access panels on an electric water heater to reach the thermostats, turn off the electricity at the circuit breaker panel. Adjust both thermostats to the same level to prevent one element from overloading and prematurely wearing out.

Finally, when you're going to be away from home for several days, turn the water heater thermostat down to the lowest setting or shut down your water heater.

### Flush sediment from the tank twice a year

Sooner or later, rust and scale will build up inside the water heater's tank, making it work less efficiently. As the water heater cycles through hot and cold periods, it expands and contracts, causing rust and scale to drop to the bottom of the tank.

To remove the sediment, follow these steps:

- ▶ Following the water heater manufacturer's directions, shut down a gas-fired water heater or turn off the power to an electric unit, and allow the tank to cool.
- ▶ Close the cold-water supply valve, or shut off the water at the meter.
- ▶ Open a hot water tap in the house.
- ▶ Open the drain valve at the bottom of the tank and let the water flow until it's clear (usually three to five gallons); catch the water in a bucket or attach a short section of garden hose and run it to the nearest drain. If the valve is clogged, remove the stem and insert a small wire through the valve into the tank to get the water flowing.
- ▶ Close the drain valve, and open the cold-water supply valve. Don't close the hot water tap until all air is exhausted from the tank and water flows from the tap.
- ▶ Following the manufacturer's directions, relight the pilot light on a gas-fired water heater or turn on the power to an electric unit.



## Is it time to buy a new water heater?

Across the United States, the majority of water heaters—well over 90 percent—are gas or electric storage tank units. That’s because their technology is proven, their cost is low and they’re locally available. However, this domination of the marketplace doesn’t mean that there aren’t other types of water heaters worth considering when it’s time for you to purchase a new one. You’ll find more details on these options on pages 14-15.

No matter which style of water heater you prefer, one thing is certain: **Choosing the most energy-efficient unit your budget allows will pay off long-term**, because the energy-cost savings you’ll realize will more than pay back the higher initial cost of purchasing a better water heater. In addition, carefully consider buying a water heater with the longest manufacturer’s warranty available; it will be priced a little higher, but likely will include upgraded insulation, better-quality internal parts and other premium features.

### Think about a new water heater before you really need one!

Most people wait until their water heater breaks down before shopping for a new one. Since they’re in a hurry to restore their hot water supply, they usually don’t take the time to shop for the water heater that best meets their needs. They often make a bad choice, settling either for a water heater that’s on sale or the unit a local plumber “uses all the time.”

You can avoid this situation with a little planning. With water heater warranties ranging from six years to “lifetime,” **it’s difficult to predict exactly when a water heater will fail**. On average, it’s probably safe to say that a water heater will last from 10 to 15 years—or possibly longer, if it’s been properly maintained and regularly serviced. However, unless you’ve lived in your home for a long time, you probably didn’t choose your present water heater; the previous owners or a builder did. As a result, you may not know how old it is, how well it’s been maintained or even if the original warranty is still in effect.

If your present water heater is showing obvious signs of old age—rust around the bottom of the tank or leaks starting to develop—you need to act immediately. But if your water heater is functioning properly and you believe it’s at least seven years old, take a little time to evaluate your hot water needs and begin comparing the various types and models on the market today—which will help you make an informed and energy-wise purchase tomorrow.

Even if your older, but inefficient, water heater is functioning properly, consider replacing it with a new, energy-efficient one. The energy savings alone could pay for the new unit within a few years, and you’ll be happy knowing that you’re dumping fewer pollutants into the air and sending less money down the drain.

### Size is not the most important consideration

You may be inclined just to look for a new water heater that’s the same size as the one you have now—replacing the old 40-gallon storage tank unit with a new 40-gallon one. That could be an expensive mistake.

For example, what if your family is growing? You’ll soon need a higher-capacity water heater. Perhaps you bought a new home—just for the two of you—that previously was occupied by a large family. You might be able to downsize the water heater or switch from a tank-style unit to a tankless device. In addition, you may want to consider a solar water heating system.

On the other hand, size could be an issue if the space for your water heater is limited—especially if the unit is located in a closet. Some of the new super-insulated water heaters are larger in diameter than their older counterparts and may not fit in the same space. In addition, many storage tank water heaters get taller as their gallon capacity increases, and gas-fired units with power venting units on the top need a little extra headroom too.

### Read the EnergyGuide label

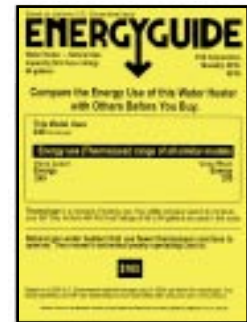

Use the EnergyGuide label to compare the operating costs of water heaters you’re considering. Each label shows estimated annual energy consumption, how a particular water heater measures up against comparable ones and estimated annual operating cost.

## Did you know?

The U.S. Department of Energy's Web site includes links to **water heating calculators** to help you:

- Estimate the lifetime energy savings of electric and gas water heaters that have varying levels of energy efficiency.
- Investigate the price, savings and system size of solar energy systems to produce electricity, heat household water and warm up a spa or pool.
- Determine your present water heater's energy usage and estimate whether a solar water heater could save you money.

To find the calculators, go to [http://www.eere.energy.gov/consumer/calculators/water\\_heating.cfm](http://www.eere.energy.gov/consumer/calculators/water_heating.cfm).

## Will your new water heater recover in time?

The first thing to consider when replacing a storage tank water heater is your need for hot water and its relationship to a number called the **first hour rating** (FHR). The first hour rating is the amount of hot water a unit can heat during the highest-demand hour of the day; some people call it “recovery time.” (Other types of water heaters use different ratings.)

This rating takes into account the tank size and how quickly cold water is heated. In some cases, a water heater with a small tank—but a powerful burner—can have a higher FHR than a water heater with a large tank and less-powerful burner. In addition, as the size of a tank increases, the standby losses of the unit also go up because the tank has a greater tank surface area. And if the system is a gas-fired unit, it also will lose some heat energy up the flue.

### Estimate peak hour demand

The chart below will help you estimate your family's hot water use for the busiest hour of the day—the family's **peak hour demand**—not the total amount of hot water everyone uses in a day. Please note that the values in this table do not consider the installation of water-conservation measures such as low-flow showerheads, faucet aerators, a front-loading clothes washer or other devices that can reduce hot water use for each activity.

Hot water use	Hot water gallons per use	Times used in 1 hour	Gallons used in 1 hour
Showering	20	x	=
Bathing	20	x	=
Shaving	2	x	=
Washing hands and face	2	x	=
Hand dishwashing	4	x	=
Automatic dishwashing	10	x	=
Preparing food	5	x	=
Clothes washing	32	x	=
<b>PEAK HOUR DEMAND</b>			=

Source: Gas Appliance Manufacturers Association and ACEEE estimates

Choose a water heater with a capacity within a couple of gallons of this peak demand. In the following example, the family uses 66 gallons of hot water first thing in the morning, making either a 50-gallon electric water heater or 40-gallon natural-gas unit with an FHR of at least 66 a good possibility. A rule of thumb is: The quicker a unit can heat water, the smaller the tank needed; the longer it takes a unit to heat water, the larger the tank needed. Tank construction, insulation thickness, controls and many other factors differ from one water heater to the next and affect the FHR, so compare all specifications and options when you go shopping.

Activity	Hot water gallons per use	Times used in 1 hour	Gallons used in 1 hour
3 showers	20	x 3	= 60
1 shave	2	x 1	= 2
Hand-wash dishes	4	x 1	= 4
<b>PEAK HOUR DEMAND</b>			= 66

Source: Gas Appliance Manufacturers Association and ACEEE estimates

## Look for efficiency too

Once you have determined the size of the storage tank water heater you need, the next step is to **decide which type and model is the most fuel-efficient**. The unit's energy factor (EF) is the best indicator of a water heater's efficiency, measuring it based on the following criteria:

- ▶ *Recovery efficiency*—how efficiently the heat from the energy source (gas, electricity or oil) is transferred to the water.
- ▶ *Standby losses*—the amount of heat lost through the tank walls and pipes.
- ▶ *Cycling losses*—the extra energy expended in the starting and stopping of the burners (on gas units only).

**The higher the EF rating, the more efficient the heater will be.** An EF of 1.00 would mean that a water heater converted 100 percent of the input energy into heated water. Practically speaking, the best electric storage tank water heaters have an EF of around .95, while the top-rated gas-fired ones are below .70. For comparable sized units, electric water heaters generally show higher numbers, because heat loss occurs only through the tank; gas units also experience losses through pilot light waste, burner operation and heat energy exhausting up the flue.

The units with the highest EF typically have the most tank insulation and incorporate heat traps, but larger tanks often have lower EFs. The manufacturer's literature usually lists the EF rating, or it can be found on the yellow EnergyGuide labels on the water heaters.

### Low price doesn't necessarily equal long-term value

It may be tempting to simply buy the cheapest model and ignore **operating costs**, but this strategy will be costly in the end. Often the least-expensive water heater to buy is the most expensive to operate. In addition, you really have to give some thought to long-term energy costs, especially if you're thinking about replacing your current water heater with one that uses a different fuel or energy source.

### Make the water heater the center of attention

If possible, **locate the water heater near the middle of your home**—or close to the hot water taps, fixture or appliances you use most often. This will lessen the opportunities for heat loss that occur in long pipe runs. Also try to minimize the length of pipe runs to your kitchen, bathrooms and laundry.

In addition, a storage tank water heater will lose less heat if it's placed in a conditioned space—but don't put it in an area that will increase the air-conditioning load on your home. On the other hand, don't install the water heater in an unheated basement.

### Installing a water heater is not a job for most home do-it-yourselfers

Devote a significant amount of time to finding the right installer; make sure the company has experience with the type of water heater you've chosen. Ask friends, neighbors and business associates for recommendations.

**Look at written bids from at least three licensed and insured local contractors**, and evaluate their estimates carefully. Ask when payment is due and by what methods—and make sure all of these items are included in the price: a statement guaranteeing that all work will meet current plumbing and/or building codes; permits (if required); draining, disconnecting and hauling away the old water heater; connecting, filling and testing the new unit; and cleaning up the work area. Before you make a final decision on what company will do the work, check references and call the local Better Business Bureau to see if there are any complaints on file.

### Where's the ENERGY STAR label?

After the latest federal standards raised the minimum energy factor (EF) for water heaters, ENERGY STAR determined that the incremental savings offered by the best gas and electric water heaters would not be large enough to justify awarding an ENERGY STAR designation to them. In fact, the rating differences between the top-performing storage tank water heaters and the least-efficient ones would be smaller than in any other ENERGY STAR appliance category. In addition, the organization felt that "nonconventional" water heaters were not yet well proven, their pay-back periods are unreasonable for average consumers and their availability is too limited.

Other organizations have discontinued their popular listings of the most energy-efficient water heaters for some of the same reasons. However, consumer magazines still run product reviews that provide helpful and detailed information about various brands of water heaters.



### Heat traps are essential

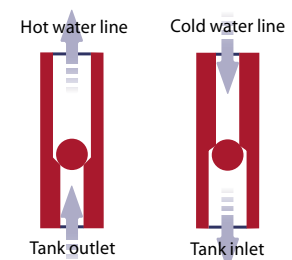

If **anti-convection valves or heat traps** for both the cold-water inlet and the hot water outlet are not included with your new water heater, make sure the installer adds them.

### Look for special features

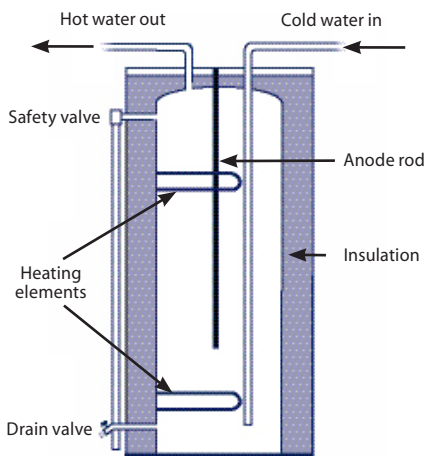

Besides the standard electric storage tank water heater shown here, there are units with extra choices you may want to consider. One type has “smart” controls with multiple modes you can set, including one that tells the computer inside to automatically adjust the water temperature to match your family’s hot water usage; this reduces standby losses when no hot water is needed. The other kind has a lifetime warranty and includes a polyethylene outer shell and a seamless molded plastic tank inside; the wide spacing between them is filled with foam insulation—even at the top, where it’s needed most.

### Did you know?

If you live in an area where the mineral content of the water is high, you can prolong the life of a water heater by installing a **sediment trap** or a **water softener** in the cold water line before it goes to the water heater.

## Should you choose an electric or gas-fired unit?

By a wide margin, storage tank water heaters are the most common type of water heater used in homes, and they typically range in capacity from 40 to 60 gallons. They’re powered by electricity, natural gas or liquid propane.

In an environment of fast-changing energy prices, it’s difficult to recommend one type of water heater over another. However, one thing is certain: Spending a little time to complete the peak hour demand chart and water heating calculators on page 10 will help you make the most economical choice after evaluating all costs—purchase price, energy consumption and maintenance—for the **lifetime** of your new water heater. In addition, if you’re thinking about changing to a water heater that uses a different energy source than the one you have now, be sure to include all of the conversion costs in your long-term calculations.

**No matter what their energy source, all storage tank water heaters operate in pretty much the same manner.** The tank is surrounded by a blanket of *insulation* and is enclosed in a *metal* or *polymer (plastic) jacket*. Cold water from the water service flows through an inlet at the top of the tank and goes down an *internal supply pipe* to the bottom of the tank. A pair of *heating elements* (electric) or a *burner* (gas) heat the water in the tank. When a tap is opened, hot water exits through an *outlet* on top of the tank; at the same time, cold water flows into the bottom to replace the outgoing heated water. A *thermostat* keeps the water at the requested temperature.

Three other components have special functions. A *pressure relief valve* located on top of the tank (or on the side, near the top) prevents excess pressure buildup in the tank caused by overheating; the valve opens to release the pressure if water inside overheats to a dangerous level. An *anode* hanging in the water in the tank helps prevent tank corrosion. And a *drain valve* near the bottom of the tank allows you to regularly drain a few gallons of water from the tank to remove rust and sediment buildup.

### Most electric water heaters require 240 volts

The energy factor (EF) rating of an electric water heater will be higher than that of a comparably sized gas water heater. An electric unit also is easy to turn off and on.

Some utilities offer special rebates on the purchase of an electric water heater—or low-block, off-peak or load-management programs that can lower the rates you pay for energy. Be sure to check on these potential money savers before you purchase a water heater.

### Keep these things in mind when you go shopping

Look for these features when you’re comparing electric storage tank water heaters:

- ▶ Long-lasting heating elements made from special materials other than standard copper.
- ▶ A magnesium anode rod that will last longer than a mild-steel anode rod.
- ▶ CFC-free tank insulation rated at R-24 or insulation that’s at least three inches thick.
- ▶ A specially coated ceramic- or porcelain-lined tank that resists corrosion more effectively than a standard glass-coated tank.
- ▶ A sediment-reduction system—such as a dip tube that creates turbulence in the tank—to reduce lime and sediment buildup.
- ▶ The longest standard manufacturer’s warranty that’s available. Sometimes the tank has different warranty than the water heater’s other components—possibly even a lifetime warranty. Most water heater warranties cover replacement parts but don’t include labor costs to replace failed parts. Also check to see if the warranty will transfer to the new owners if you sell your home.
- ▶ Heat traps to prevent heat loss caused by siphoning of heated water into pipes.
- ▶ A brass (not plastic) drain valve.

## There are two types of gas unit to consider

A natural gas or propane water heater generally will be less efficient than an electric one, with an EF for the most-efficient gas models running about .62. A gas unit can lose up to a quarter of its heating energy during the combustion process while heating the water; much of the waste heat just goes up the flue and out the chimney. On the other hand, a natural gas water heater may be less expensive to operate than an electric unit when lifetime energy costs are considered. In addition, utilities may offer special rebates or energy pricing that will have a favorable effect on the long-term cost of owning a gas water heater.

For all types of gas water heaters, **appropriate venting is essential** for proper operation and your family's safety. The *standard vent* that comes with most basic gas-fired water heaters is a simple unit that directs combustion byproducts through a flue that passes through the middle of the tank, up the chimney and out of your home. However, if you live in a very airtight house, the flue is extremely long or the water heater is located in a conditioned space, choose a water heater with a *power vent* that uses a fan to carry the exhaust outside; you probably will need to add an outside air intake for improved combustion too. Finally, a *direct vent* that combines the exhaust flue and an outside-air intake into a single unit might be a good choice if locating the water heater along an outside wall makes sense in your home. Since a direct vent relies on natural air currents—there's no fan involved—the vent only can extend about four feet from the water heater to the outside of the house.

## Keep these things in mind when you go shopping

Look for these features when you're comparing gas storage tank water heaters:

- ▶ A super-efficient, sealed combustion chamber with a burner that reduces nitrous oxide (NO<sub>x</sub>) emissions.
- ▶ Compliance with flammable vapor ignition resistant (FVIR) standards that prevent unintended ignition of flammable vapors from products such as solvents, cleaning products, gasoline, aerosol sprays and adhesives.
- ▶ Viewing window to check burner function.
- ▶ Piezoelectric (pushbutton) or electronic pilot light igniter.
- ▶ A magnesium anode rod that will last longer than a mild-steel anode rod.
- ▶ CFC-free tank insulation rated at R-16 or insulation that's at least two inches thick.
- ▶ A specially coated ceramic- or porcelain-lined tank that resists corrosion more effectively than a standard glass-coated tank.
- ▶ A sediment-reduction system—such as a dip tube that creates turbulence in the tank—to reduce lime and sediment buildup.
- ▶ The longest standard manufacturer's warranty that's available. Sometimes the tank has a different warranty than the water heater's other components—possibly even a lifetime warranty. Most water heater warranties cover replacement parts but don't include labor costs to replace failed parts. Also check to see if the warranty will transfer to the new owners if you sell your home.
- ▶ Heat traps to prevent heat loss caused by siphoning of heated water into pipes.
- ▶ A brass (not plastic) drain valve.

### Your home needs a CO detector on every level

Carbon monoxide (CO) is an invisible, odorless and colorless gas created when fossil fuels such as natural gas, propane or oil burn incompletely. The best way to prevent CO poisoning is to properly install CO detectors in your home. Look for alarms that have been certified by an independent testing laboratory (such as UL), and follow the manufacturer's instructions for installing them. If an alarm sounds, open the windows immediately to ventilate the area and move everyone outside to fresh air. Then call your fire department and utility; they will bring test equipment to locate the source of the CO.

## Consider the recovery time

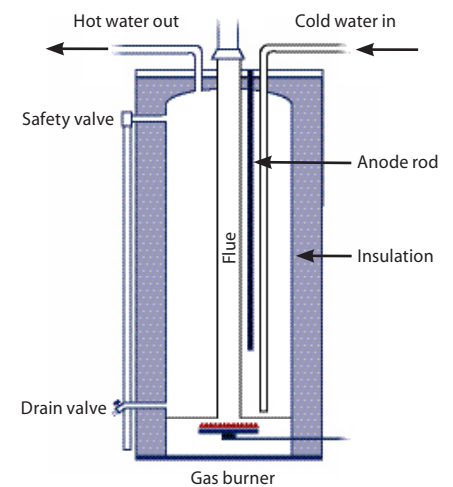

In a natural gas or propane storage tank water heater, the burner sits below the water tank—but within the insulated shell of the unit. In most cases, recovery time for a gas water heater will be shorter than that of an electric unit.



### Did you know?

Installing an energy-efficient heating-and-cooling system in your home can make your new gas water heater an "orphan." If your home now is very airtight—and you've installed an air-source heat pump, a geothermal heat pump or a gas forced-air heating system that uses outside air for combustion, the exhaust fumes from the water heater may not properly flow up the chimney that originally was sized to handle exhaust from both the water heater and the old gas furnace. (During cold weather, the exhaust from the water heater may condense on the inside of the chimney flue and run back into your home too.) To fix this situation, have a technician install a chimney liner to reduce the flue's volume or choose a power-vented water heater.



## Instant hot water

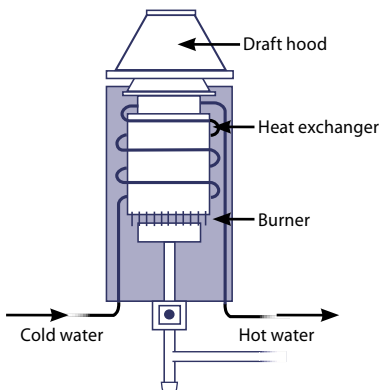

A tankless water heater can be a sensible choice in a home occupied by just one or two people—or a family with a schedule that doesn't require multiple hot water uses at the same time.

### ? Did you know?

Freestanding **heat pump water heaters** disappeared from the marketplace almost as fast as the devices came into it. They were expensive, fairly unreliable and needed a boost from electric heating elements to produce sufficient hot water for an average family—especially in cold weather. However, some of the manufacturers of heat pump water heaters turned their attentions to serving larger, commercial customers with great success, so it's probably only a short matter of a time before new-and-improved, energy-saving and practical units are released again for homeowners.

## Demand is growing for tankless water heaters

Ten years ago, tankless water heaters—also called *on-demand* or *instantaneous* water heaters—mostly were a curiosity in the American marketplace. But a new push for energy efficiency (plus significant recent improvements in the performance characteristics of these devices) makes **whole-house tankless units** worth a second look for some homeowners.

### Where's the water storage tank?

A tankless water heater isn't much larger than a briefcase, and it heats water only when there's a demand for it. The cold water enters the unit and passes through a heat exchanger, where it's heated by a high-powered electric element or gas burner. An electronic control unit keeps tabs on the water temperature and flow rate, shutting down the unit when hot water no longer is requested; however, **the unit will continue to provide hot water as long as it's needed**, unlike a storage tank water heater that needs time to recover before it can supply another tankful of hot water. Typically, a gas tankless unit heats faster and more efficiently than an electric one.

A tankless water heater is rated by **flow rate**—the number of gallons of hot water it can produce per minute at a particular temperature increase. And therein lies a problem: A tankless water heater cannot provide large amounts of hot water at the same rate as a conventional water heater can, meaning the tankless unit may not be a good choice for a family that uses more than one shower—or the clothes washer and the dishwasher—simultaneously. On the other hand, a tankless unit could provide all the hot water needed if each shower or appliance was used one after the other. Tankless systems are most effective when water-saving showerheads and faucet aerators are in use.

**The greatest disadvantage of a tankless unit is the cost of purchasing and installing one.** The price for a unit that can adequately service a typical household will be much higher than for a storage tank water heater, and—depending on your family's size and water-using habits—its payback will take much longer too.

Another drawback for an electric tankless water heater is that a home may need upgraded electrical service, since a tankless unit draws a lot of power when it's in operation—more than 100 amps for some units. Typical residential wiring often will not support a tankless electric water heater with a large enough capacity to serve multiple uses—and the operating costs for an electric unit are higher than those of a gas one—so if you rely on electricity to heat your water, a tankless system is unlikely to meet your needs.

## Use your air conditioner to heat water

An air-conditioning system can heat water with the addition of a **desuperheater**—a heat-recovery unit that captures waste heat from a central air conditioner, air-to-air heat pump or geothermal heat pump and uses it to preheat the water in a storage tank water heater. There are two basic types of desuperheater.

When you add a desuperheater to a **central air conditioner or air-to-air heat pump system**, the desuperheater can provide hot water at little or no cost—and improve the efficiency of the air conditioner when the unit is in use. **Because the desuperheater only works when the air conditioner is running** (five to seven months of the year), a backup water-heating source is necessary for cool- and cold-weather months. An add-on desuperheater is relatively expensive, too, so the payback period for the unit in Iowa will be pretty slow. Ask a heating and cooling contractor for a detailed analysis on whether a desuperheater makes sense for your home, and make sure adding one will not void your existing cooling system's warranty.

## Is it practical to heat water with the sun?

Although there are many types of solar water heating systems available, the best choice for Iowa homeowners is either an **indirect circulation** or **drain-back** system. In the indirect closed-loop system, a small electric pump regulated by a system controller circulates a non-freezing heat-transfer fluid such as a glycol-water antifreeze mix through a roof-mounted solar thermal collector. The fluid then moves from one or more collectors down to a heat exchanger that's located in an insulated solar storage tank, preheating the water before it flows to a conventional gas or electric storage tank water heater. This water heater is used for backup on cloudy days and for times of unusually high demand for hot water. The drain-back system works in a similar way, except the liquid in the collectors and exposed pipes drains into an insulated reservoir tank each time the circulation pump shuts off.

To get the most out of a solar water heating system in Iowa, **the collectors need an unobstructed, south-facing view of the sun for as much of the day as possible**—at least three hours before and after solar noon. Shading from neighboring trees, a building next door or even a chimney or parts of the roof upon which the collector sits will reduce the system's effectiveness.

On a bright and sunny day, you won't need to install a huge array of collectors on your roof to provide enough hot water for a family of four. In fact, a solar thermal collector measuring about 64 square feet should handle the needs of a family of four. (Figure 20 square feet of collector for the first two family members, and add 12-14 square feet for each additional person.) For storage tank capacity, figure 1.5 gallons per square foot of collector size.

**A well-designed, properly installed and maintained solar water heating system typically can supply up to half of the annual water-heating needs for a typical family.** While the initial cost of a solar water heating system is high, utility company rebates and/or tax credits can shorten the system's payback period by a significant amount. You will realize the greatest financial benefit from a solar water heating system if you have a large water heating load and currently heat water with electricity and pay high electric rates—or if you use propane.

Good sources of information on solar energy topics include the Florida Solar Energy Center (<http://www.fsec.ucf.edu>), the American Solar Energy Society (<http://www.ases.org>) and the Energy Efficiency and Renewable Energy in Iowa page from the U.S. Department of Energy ([http://www.eere.energy.gov/states/state\\_specific\\_information.cfm/state=IA](http://www.eere.energy.gov/states/state_specific_information.cfm/state=IA)). In addition, you can get a rough idea of the potential cost, energy savings and system size for a solar water heating system installed in a home in any county in the U.S. at Find Solar (<http://www.findsolar.com>). **Before you buy solar equipment, make sure the components are certified and rated** by the nonprofit Solar Rating and Certification Corporation; for details, go to the organization's Web site at <http://www.solar-rating.org>.

### Indirect circulation system

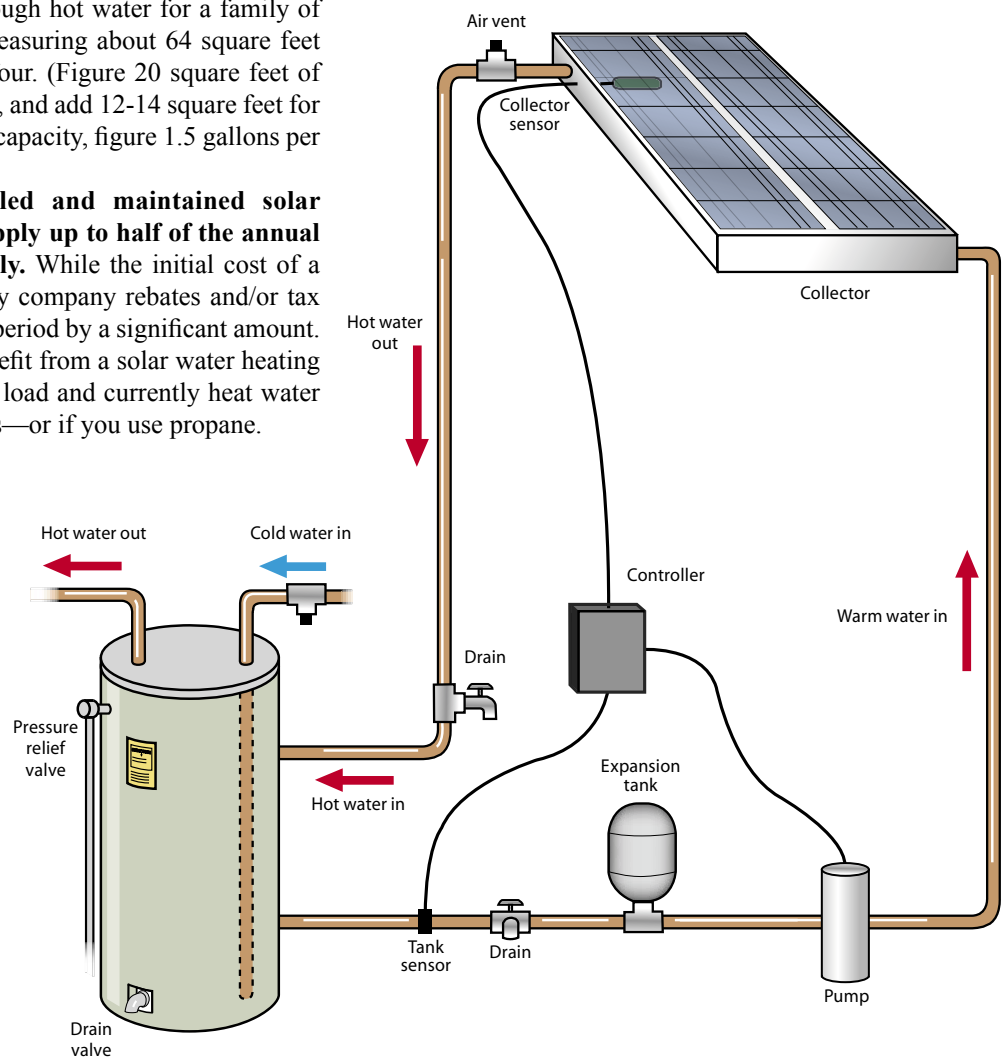

**Alliance to Save Energy**

1200 18th Street NW, Suite 900  
Washington, DC 20036  
Phone: 202-857-0666  
Web site: <http://www.ase.org/>

**Alliant Energy**

4902 North Biltmore Lane  
P.O. Box 77007  
Madison, WI 53707-1007  
Phone: 800-255-4268  
Web site: <http://www.alliantenergy.com/>

**American Council for an  
Energy-Efficient Economy**

1001 Connecticut Avenue, NW, Suite 801  
Washington, DC 20036  
Phone: 202-429-8873  
Fax: 202-429-2248  
Web site: <http://www.aceee.org/>

**Aquila, Inc.**

1701 48th Street, Suite 260  
West Des Moines, IA 50266  
Phone: 816-421-6600  
Web site: <http://www.aquila.com>

**Atmos Energy Corporation**

24 South 10th Street  
Keokuk, IA 52632  
Phone: 888-824-3434  
Web site: <http://www.atmosenergy.com/>

**Energy Efficient Rehab Advisor**

Web site: <http://rehabadvisor.pathnet.org/>

**ENERGY STAR**

1200 Pennsylvania Avenue, NW  
Washington, DC 20460  
Phone: 888-782-7937  
Web site: <http://www.energystar.gov/>

**Home Energy Saver**

Environmental Energy Technologies Division  
at the Lawrence Berkeley National Laboratory  
Web site: <http://hes.lbl.gov/>

**IowaENERGY.org**

Web site: <http://www.iowaenergy.org/>

**Iowa Association of Electric Cooperatives**

8525 Douglas, Suite 48  
Des Moines, IA 50322-2992  
Phone: 515-276-5350  
Fax: 515-276-7946  
Web site: <http://www.iowarec.org/>

**Iowa Association of Municipal Utilities**

735 NE 70th Avenue  
Ankeny, IA 50021-9353  
Phone: 515-289-1999  
Fax: 515-289-2499  
Web site: <http://www.iamu.org/>

**Iowa Department of Human Rights/  
Division of Community Action Agencies**

Lucas State Office Building  
Des Moines, IA 50319  
Phone: 515-281-0859  
Fax: 515-242-6119  
Web site: <http://www.dcaa.iowa.gov>

**Iowa Department of Natural Resources**

502 E. 9th Street  
Des Moines, IA 50319-0034  
Phone: 515-281-5918  
Web site: <http://www.iowadnr.com/>

**Iowa Renewable Energy Association**

P.O. Box 3405  
Iowa City, IA 52244-3405  
Phone: 563-432-6551  
Web site: <http://www.irenew.org/>

**Iowa State University Extension**

Answer Line Phone: 800-262-3804  
Web site: <http://www.extension.iastate.edu/>  
answerline/  
or <http://www.extension.iastate.edu/housing/>

**MidAmerican Energy**

666 Grand Avenue  
P.O. Box 657  
Des Moines, IA 50303-0657  
Phone: 888-427-5632  
Web site: <http://www.midamericanenergy.com/>

**U.S. Department of Energy Office of  
Energy Efficiency and Renewable Energy**

Mail Stop EE-1  
Department of Energy  
Washington, DC 20585  
Phone: 877-337-3463  
Web site: <http://www.eere.energy.gov/>

**U.S. Environmental Protection Agency**

1200 Pennsylvania Avenue, NW  
Washington, DC 20460  
Phone: 202-272-0167  
Web site: <http://www.epa.gov/>



**This is an Iowa Energy Center publication.**

The Iowa Energy Center is a research, demonstration and education organization dedicated to improving Iowa's energy efficiency and use of renewable energy. The Energy Center meets its goals by developing in-house energy research and education programs and by sponsoring energy projects developed by other groups. The projects supported by the Energy Center, which vary in size and complexity, are conducted throughout the state in Iowa's universities, colleges, community colleges and private nonprofit organizations.

**Iowa Energy Center**

2521 Elwood Drive, Suite 124, Ames, IA 50010-8229  
Phone: 515-294-8819 | Fax: 515-294-9912 | E-mail: [iec@energy.iastate.edu](mailto:iec@energy.iastate.edu)  
Web site: <http://www.energy.iastate.edu>

